

サイン計画

計画図

1

建設局工区

2017年8月

新宿ターミナル協議会

【指示・同定サイン】

	器具寸法	設置形式	表示	照明方式	サイン番号	台数	摘要
器具取替	H450 × W8000 × D140	吊下型	両面	内照	C-01, C-02, C-03, C-06, C-09, C-10, C-13, C-14, C-15, C-16, C-17, C-20, C-21	13	
	H450 × W6000 × D140	吊下型	両面	内照	C-05, C-07, C-19	3	
	H450 × W5500 × D140	吊下型	両面	内照	C-18	1	
	H450 × W5000 × D140	吊下型	両面	内照	C-04, C-11, C-12	3	
	H450 × W4500 × D140	吊下型	両面	内照	C-22, C-23, C-24	3	
	H450 × W4000 × D140	吊下型	片面	内照	C-46	1	
	H450 × W4000 × D140	吊下型	両面	内照	C-08	1	
	H450 × W3200 × D140	吊下型	片面	内照	C-47(※), C-48, C-53, C-54	4	※ C-47は2台一組
	H450 × W2400 × D140	吊下型	両面	内照	C-25, C-27, C-29, C-31, C-49, C-50, C-56	7	
	H450 × W2400 × D140	吊下型	片面	内照	C-26, C-28, C-30, C-32, C-34, C-36, C-38, C-40, C-45	9	
	H450 × W2100 × D140	吊下型	両面	内照	C-33, C-35, C-37, C-39, C-44	5	
	H450 × W1600 × D140	吊下型	両面	内照	C-41, C-42, C-43, C-51, C-52, C-55	6	
	H175 × W1330 (表示面)	柱巻型	片面	内照	C-67, C-68, C-69, C-70	6	
合計						62	

【指示・同定サイン】

	表示面寸法	設置形式	表示	照明方式	サイン番号	台数	摘要
器具取替	H455 × W2640 × D90	腰壁型	片面	内照	C-57, C-58, C-59, C-60, C-61, C-62, C-63, C-64	8	
	合計						8

【図解サイン】

	器具寸法	設置形式	表示	照明方式	サイン番号	台数	摘要
新設	H2880 × W2600 × D200	壁付型	片面	内照	C-図01	1	
	H2000 × W2500 × D40	壁付型	片面	無灯	C-図02	1	
	H2000 × W2000 × D40	壁付型	片面	無灯	C-図03, C-図04, C-図05, C-図06, C-図07	5	
	合計						7

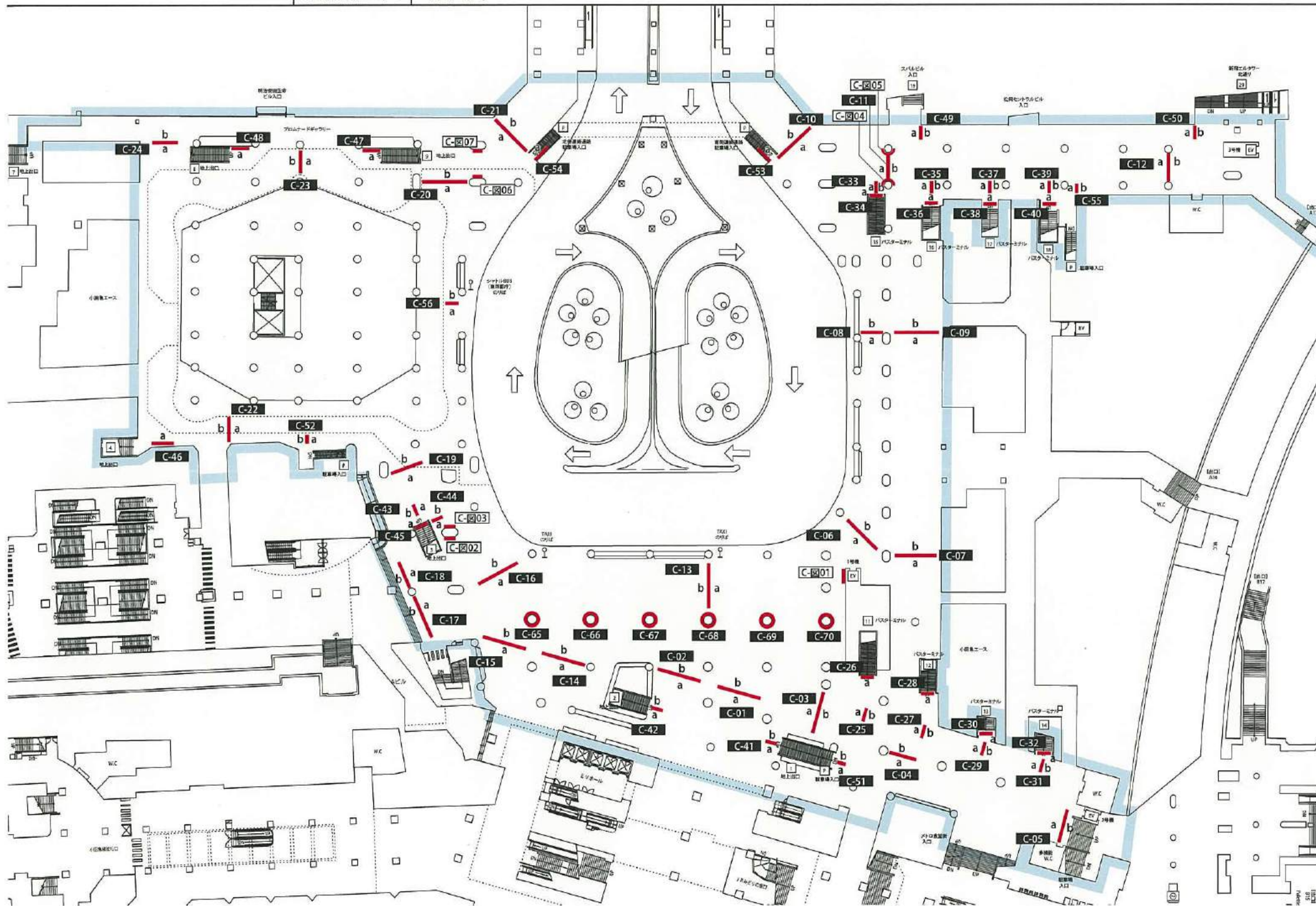

C-57 取付位置

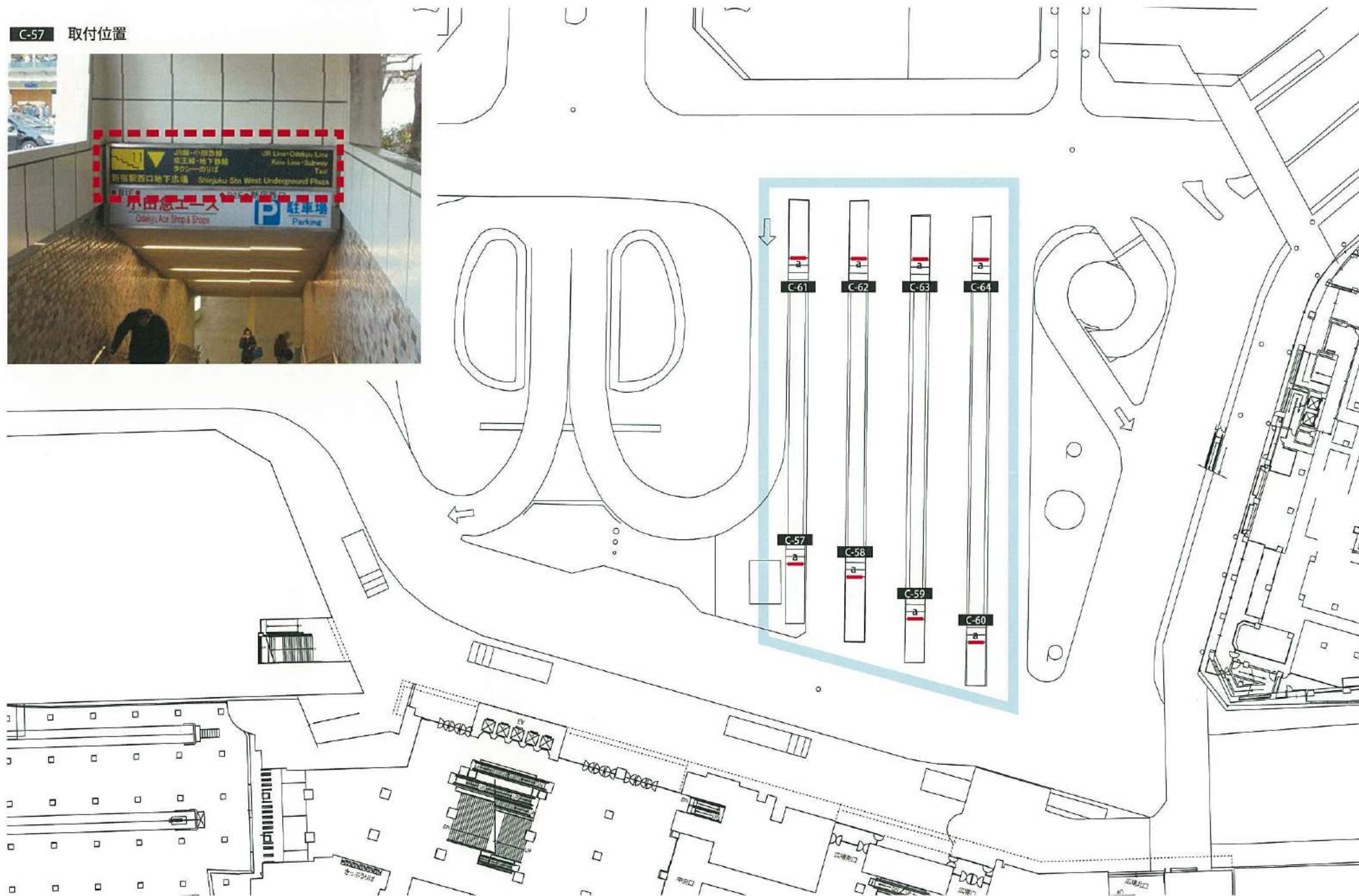

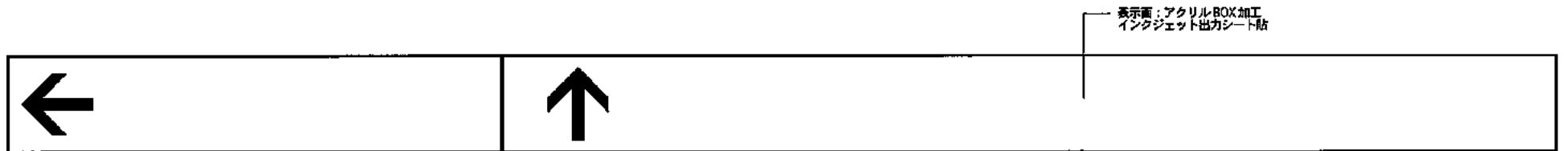
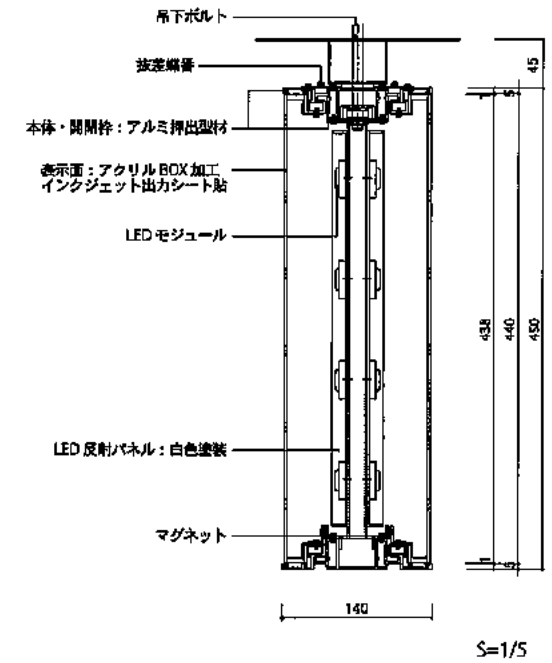
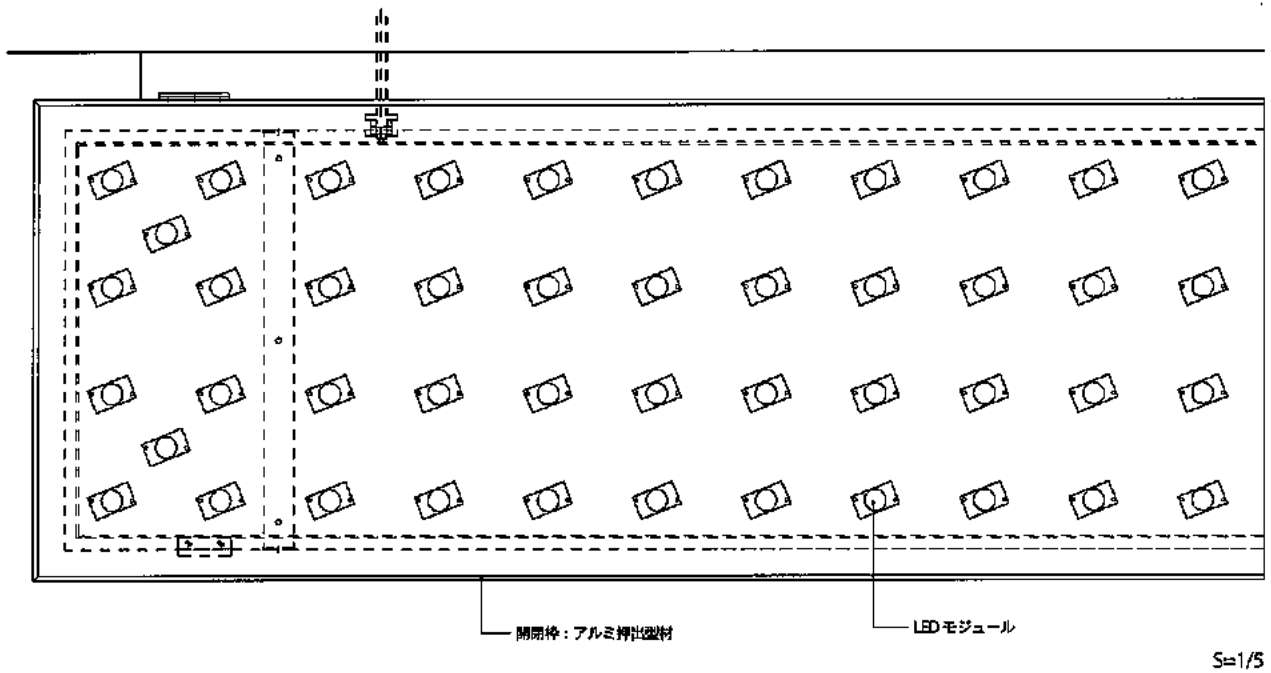

※ 指示方向ごとに表示枠を分割

レイアウト基本図 (S=1/10)

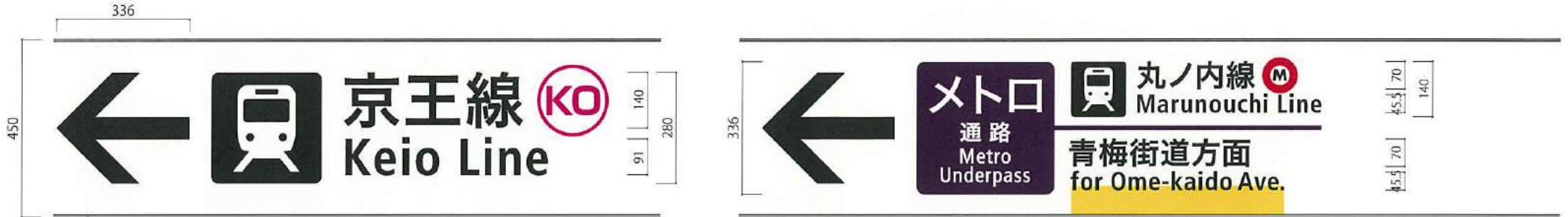

C-01 -a 器具外形寸法H450×W8000 (和文文字高70, 140)



C-01 -b



C-02 -a 器具外形寸法H450×W8000 (和文文字高70, 140)



C-02 -b



C-03 -a 器具外形寸法H450×W8000 (和文文字高70, 140)

	東京都庁方面 for Met. Government		西口バスのりば West Bus Station	メトロ 通路 Metro Underpass	丸ノ内線 Marunouchi Line	大江戸線新宿西口駅 Oedo Line, Shinjuku-nishiguchi Sta.	西武新宿 駅前 Seibu Shinjuku Square	西武線 Seibu Line	東口 East Square
	青梅街道方面 for Ome-kaido Ave.		新宿三丁目方面 for Shinjuku 3		新宿三丁目方面 for Shinjuku 3		歌舞伎町方面 for Kabukicho		

C-03 -b

	JR線 JR Lines	小田急線 Odakyu Line		京王線 Keio Line	京王新線 通路 Keio New Line Concourse	東京都庁・中央公園方面 for Met. Government, Chuo Park	
--	---------------------	----------------------------	--	----------------------	---------------------------------------	---	--

C-04 -a 器具外形寸法H450×W5000 (和文文字高70)

東口 East Square	西武線 Seibu Line	西武新宿 駅前 Seibu Shinjuku Square	大江戸線新宿西口駅 Oedo Line, Shinjuku-nishiguchi Sta.	丸ノ内線 Marunouchi Line	メトロ 通路 Metro Underpass	
	歌舞伎町方面 for Kabukicho		新宿三丁目方面 for Shinjuku 3	青梅街道方面 for Ome-kaido Ave.		

C-04 -b

	メトロ 通路 Metro Underpass	丸ノ内線 Marunouchi Line	大江戸線新宿西口駅 Oedo Line, Shinjuku-nishiguchi Sta.	西武新宿 駅前 Seibu Shinjuku Square	西武線 Seibu Line	東口 East Square
	青梅街道方面 for Ome-kaido Ave.	新宿三丁目方面 for Shinjuku 3		歌舞伎町方面 for Kabukicho		

C-05 -a 器具外形寸法H450×W6000 (和文文字高70)

	メトロ 通路 Metro Underpass	丸ノ内線 Marunouchi Line	大江戸線新宿西口駅 Oedo Line, Shinjuku-nishiguchi Sta.	西武新宿 駅前 Seibu Shinjuku Square	西武線 Seibu Line	東口 East Square
	青梅街道方面 for Ome-kaido Ave.	新宿三丁目方面 for Shinjuku 3		歌舞伎町方面 for Kabukicho		













C-05 -b

	西口 地下広場 West Concourse	JR線 JR Lines	小田急線 Odakyu Line	京王線 Keio Line	京王新線 通路 Keio New Line Concourse	京王新線 Keio New Line	都営新宿線 Shinjuku Line	南口 South Concourse
	西口バスのりば West Bus Station	東京都庁・中央公園方面 for Met. Government, Chuo Park		大江戸線新宿駅 Oedo Line, Shinjuku Sta.	甲州街道方面 for Koshu-kaido Ave.			

C-06 -a 器具外形寸法H450×W8000 (和文文字高70, 140)

 <p>東京都庁・中央公園方面 for Met. Government, Chuo Park</p>	<p>出口 Exit N1-N6</p>	<p>出口 Exit 19, 20</p>	<p>  大江戸線新宿西口駅 Oedo Line, Shinjuku-nishiguchi Sta. </p> <p>  丸ノ内線 Marunouchi Line </p> <p>  メトロ 通路 Metro Underpass </p> <p>  西口バスのりば West Bus Station </p> <p>  </p>
---	---------------------------------	----------------------------------	---

C-06 -b

<p>  </p> <p>  JR線 JR  小田急線 Odakyu Line  京王線 Keio Line </p>	<p>  高速・空港バス(バスタ新宿) Expwy Bus, Airport Bus </p> <p>  新宿御苑方面 for Shinjuku Gyoen National Garden </p> <p>  南口 South Concourse </p>	<p>  都営新宿線  京王新線 Shinjuku Line Keio New Line </p> <p>  京王新線 通路 Keio New Line Concourse </p> <p>  TAXI </p> <p>  </p>
--	--	---

C-07 -a 器具外形寸法H450×W6000 (和文文字高70, 140)

<p>  </p> <p>東京都庁・中央公園方面 for Met. Government, Chuo Park</p>	<p>出口 Exit N1-N6</p>	<p>出口 Exit 19, 20</p>
---	---------------------------------	----------------------------------

C-07 -b

<p>  </p> <p>  西口バスのりば West Bus Station </p>	<p>  メトロ 通路 Metro Underpass </p> <p>  丸ノ内線  大江戸線新宿西口駅 Marunouchi Line Oedo Line, Shinjuku-nishiguchi Sta. </p> <p>  新宿三丁目方面 for Shinjuku 3 </p>	<p>  西武新宿 駅前 Seibu Shinjuku Square </p> <p>  西武線 歌舞伎町方面 for Kabukicho </p>	<p>  東口 East Square </p>
---	--	--	--

C-08 -a 器具外形寸法H450×W4000 (和文文字高70, 140)

<p>  </p> <p>東京都庁・中央公園方面 for Met. Government, Chuo Park</p>	<p>出口 Exit N1-N6</p>
---	---------------------------------

C-08 -b

<p>  </p> <p>  JR線 JR  小田急線 Odakyu Line  京王線 Keio Line </p>	<p>  TAXI </p>
--	---

C-09 -a 器具外形寸法H450×W8000 (和文文字高70, 140)

東京都庁・中央公園方面 for Met. Government, Chuo Park	西口バスのりば West Bus Station
出口 Exit N1-N6	出口 Exit 19, 20

C-09 -b

	新宿三丁目方面 for Shinjuku 3	丸ノ内線 Marunouchi Line	大江戸線新宿西口駅 Oedo Line, Shinjuku-nishiguchi Sta.	西武新宿 駅前 Seibu Shinjuku Square	西武線 Seibu Line	東口 East Square	京王新線 通路 Keio New Line Concourse	京王新線 Keio New Line	都営新宿線 Shinjuku Line	南口 South Concourse	高速・空港バス(バスタ新宿) Expwy Bus, Airport Bus 新宿御苑方面 for Shinjuku Gyoen National Garden
--	---------------------------	-------------------------	--	--	-------------------	----------------------	--	-----------------------	------------------------	--------------------------	--

C-10 -a 器具外形寸法H450×W8000

東京都庁・中央公園方面 for Met. Government, Chuo Park	出口 Exit N1-N6
出口 Exit 19, 20	西口バスのりば West Bus Station

C-10 -b

	西口バスのりば West Bus Station	都営新宿線 Shinjuku Line	京王新線 Keio New Line	京王新線 通路 Keio New Line Concourse	大江戸線新宿西口駅 Oedo Line, Shinjuku-nishiguchi Sta.	丸ノ内線 Marunouchi Line	メトロ 通路 Metro Underpass	小田急線 Odakyu Line	JR JR線 JR Lines	西口 地下広場 West Concourse	
		甲州街道方面 for Koshu-kaido Ave.		大江戸線新宿駅 Oedo Line, Shinjuku Sta.		新宿三丁目方面 for Shinjuku 3					

C-11 -a 器具外形寸法H450×W5000

京王新線 通路 Keio New Line Concourse	大江戸線新宿西口駅 Oedo Line, Shinjuku-nishiguchi Sta.	丸ノ内線 Marunouchi Line	メトロ 通路 Metro Underpass	小田急線 Odakyu Line	JR JR線 JR Lines	西口 地下広場 West Concourse	
		新宿三丁目方面 for Shinjuku 3					

C-11 -b

	西口 地下広場 West Concourse	JR JR線 JR Lines	小田急線 Odakyu Line	京王新線 通路 Keio New Line Concourse	京王新線 Keio New Line	都営新宿線 Shinjuku Line	甲州街道方面 for Koshu-kaido Ave.
		新宿三丁目方面 for Shinjuku 3		大江戸線新宿駅 Oedo Line, Shinjuku Sta.			

C-12 -a 器具外形寸法H450×W5000

東口 East Square

西武線 Seibu Line | 西武新宿駅前 Seibu Shinjuku Square

歌舞伎町方面 for Kabukicho

大江戸線新宿西口駅 Oedo Line, Shinjuku-nishiguchi Sta. | 丸ノ内線 Marunouchi Line

新宿三丁目方面 for Shinjuku 3 | 青梅街道方面 for Ome-kaido Ave.

メトロ 通路 Metro Underpass



C-12 -b



西口 地下広場 West Concourse

JR線 JR Lines | 小田急線 Odakyu Line

京王線 Keio Line | TAXI

京王新線 通路 Keio New Line Concourse | 京王新線 Keio New Line | 都営新宿線 Shinjuku Line

大江戸線新宿駅 Oedo Line, Shinjuku Sta. | 甲州街道方面 for Koshu-kaido Ave.

C-13 -a 器具外形寸法H450×W8000 (和文文字高70, 140)



JR線 JR Lines | 小田急線 Odakyu Line



京王線 Keio Line

京王新線 通路 Keio New Line Concourse | 京王新線 Keio New Line | 都営新宿線 Shinjuku Line

大江戸線新宿駅 Oedo Line, Shinjuku Sta. | 甲州街道方面 for Koshu-kaido Ave.

南口 South Concourse

高速・空港バス(バス新宿) Expwy Bus, Airport Bus

新宿御苑方面 for Shinjuku Gyoen National Garden

C-13 -b

東口 East Square

西武線 Seibu Line | 西武新宿駅前 Seibu Shinjuku Square

歌舞伎町方面 for Kabukicho

大江戸線新宿西口駅 Oedo Line, Shinjuku-nishiguchi Sta. | 丸ノ内線 Marunouchi Line

新宿三丁目方面 for Shinjuku 3 | 青梅街道方面 for Ome-kaido Ave.

メトロ 通路 Metro Underpass

西口バスのりば West Bus Station



C-14 -a 器具外形寸法H450×W8000 (和文文字高70, 140)

東口 East Square

西武線 Seibu Line | 西武新宿駅前 Seibu Shinjuku Square

歌舞伎町方面 for Kabukicho

大江戸線新宿西口駅 Oedo Line, Shinjuku-nishiguchi Sta. | 丸ノ内線 Marunouchi Line

新宿三丁目方面 for Shinjuku 3 | 青梅街道方面 for Ome-kaido Ave.

メトロ 通路 Metro Underpass

西口バスのりば West Bus Station



C-14 -b



西口バスのりば West Bus Station

メトロ 通路 Metro Underpass

丸ノ内線 Marunouchi Line | 大江戸線新宿西口駅 Oedo Line, Shinjuku-nishiguchi Sta.

青梅街道方面 for Ome-kaido Ave. | 新宿三丁目方面 for Shinjuku 3

西武新宿駅前 Seibu Shinjuku Square | 西武線 Seibu Line

歌舞伎町方面 for Kabukicho

東口 East Square

C-15 -a V450×W8000 (和文文字高70, 140)

  京王線 Keio Line	 東京都庁方面 for Met. Government	 京王新線 Keio New Line Concourse	 京王新線 都営新宿線 Keio New Line Shinjuku Line	 南口 South Concourse	 高速・空港バス(バスタ新宿) Expwy Bus, Airport Bus	  TAXI
--	--	---	---	--	--	--

C-15 -b

  JR線 JR Lines	 小田急線 Odakyu Line	 観光案内所 Tourist Information		 京王線 Keio Line	
--	--	--	--	---	---







C-16 -a 器具外形寸法H450×W8000 (和文文字高70, 140)

  京王線 Keio Line		 京王新線 Keio New Line Concourse	 京王新線 都営新宿線 Keio New Line Shinjuku Line	 南口 South Concourse	 高速・空港バス(バスタ新宿) Expwy Bus, Airport Bus	東京都庁方面 for Met. Government
--	---	--	---	--	--	--------------------------------------







C-16 -b

  西口バスのりば West Bus Station	観光案内所 Tourist Information	 小田急線 Odakyu Line	 JR線 JR Lines		 京王線 Keio Line	
---	-------------------------------------	--	--	---	---	---

C-17 -a 器具外形寸法H450×W8000 (和文文字高70, 140)

  京王線 Keio Line	 高速・空港バス(バスタ新宿) Expwy Bus, Airport Bus	 南口 South Concourse	 都営新宿線 京王新線 Shinjuku Line Keio New Line	 京王新線 Keio New Line Concourse	
---	--	--	---	--	---

C-17 -b

  西口バスのりば West Bus Station	 メトロ Metro Underpass	 丸ノ内線 大江戸線新宿西口駅 Marunouchi Line Oedo Line, Shinjuku-nishiguchi Sta.	青梅街道方面 新宿三丁目方面 for Ome-kaido Ave. for Shinjuku 3	 小田急線 Odakyu Line	 JR線 JR Lines	
--	---	---	---	--	--	---

C-18 -a 器具外形寸法H450×W5500 (和文文字高70, 140)



C-18 -b



C-19 -a 器具外形寸法H450×W6000 (和文文字高70, 140)



C-19 -b



C-20 -a 器具外形寸法H450×W8000 (和文文字高70, 140)



C-20 -b

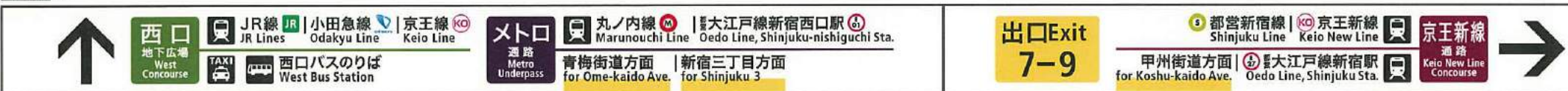

C-21 -a 器具外形寸法H450×W8000 (和文文字高70, 140)

 <p>出口 Exit 7-9</p>	 <p>東京都庁・中央公園方面 for Met. Government, Chuo Park</p>	<p>出口 Exit S1-S3</p>
--	--	---------------------------------

C-21 -b

	<p>西口 地下広場 West Concourse</p> <p>JR線 JR Lines 小田急線 Odakyu Line 京王線 Keio Line</p> <p>TAXI 西口バスのりば West Bus Station</p>	<p>メトロ 通路 Metro Underpass</p> <p>丸ノ内線 Marunouchi Line 大江戸線新宿西口駅 Oedo Line, Shinjuku-nishiguchi Sta.</p> <p>青梅街道方面 新宿三丁目方面 for Ome-kaido Ave. for Shinjuku 3</p>	<p>出口 Exit 7-9</p>	<p>都営新宿線 Shinjuku Line 京王新線 Keio New Line 京王新線 Keio New Line</p> <p>甲州街道方面 大江戸線新宿駅 for Koshu-kaido Ave. Oedo Line, Shinjuku Sta.</p> <p>京王新線 Keio New Line 通路 Concourse</p>	
--	---	--	-------------------------------	--	---

C-22 -a 器具外形寸法H450×W4500 (和文文字高70, 140)

	<p>京王線 Keio Line</p>	<p>南口 South Concourse</p>	<p>都営新宿線 Shinjuku Line 京王新線 Keio New Line 京王新線 Keio New Line</p> <p>甲州街道方面 大江戸線新宿駅 for Koshu-kaido Ave. Oedo Line, Shinjuku Sta.</p>	
--	-----------------------------	--------------------------------------	--	---

C-22 -b

	<p>JR線 JR Lines 小田急線 Odakyu Line</p> <p>TAXI 西口バスのりば 東京都庁・中央公園方面 West Bus Station for Met. Government, Chuo Park</p>	<p>京王線 Keio Line</p> 
---	---	---

C-23 -a 器具外形寸法H450×W4500 (和文文字高70, 140)

	<p>京王新線 Keio New Line 通路 Concourse</p> <p>京王新線 Keio New Line 都営新宿線 Shinjuku Line</p> <p>大江戸線新宿駅 Oedo Line, Shinjuku Sta. 甲州街道方面 for Koshu-kaido Ave.</p>	<p>南口 South Concourse</p>	<p>高速・空港バス(バスタ新宿) Expwy Bus, Airport Bus</p> <p>新宿御苑方面 for Shinjuku Gyoen National Garden</p>
---	---	--------------------------------------	---

C-23 -b

	<p>東京都庁・中央公園方面 for Met. Government, Chuo Park</p>	<p>出口 Exit S1-S3</p>
---	--	---------------------------------

C-24 -a 器具外形寸法H450×W4500 (和文文字高70, 140)



C-24 -b



C-25 -a 450×2400 (和文文字高120)



C-25 -b



C-26 -a (b面なし) 450×2400 (和文文字高70)



C-27 -a 450×2400 (和文文字高120)



C-27 -b



C-28 -a (b面なし) 450×2400 (和文文字高70)



C-29 -a 450×2400 (和文文字高120)



C-29 -b



C-30 -a (b面なし) 450×2400 (和文文字高70)



C-31 -a 450×2400 (和文文字高120)



C-31 -b



C-32 -a (b面なし) 450×2400 (和文文字高70)



C-33 -a 450×2100 (和文文字高120)



C-33 -b



C-35 -a 450×2100 (和文文字高120)



C-35 -b



C-37 -a 450×2100 (和文文字高120)



C-37 -b



C-39 -a 450×2100 (和文文字高120)



C-39 -b



C-34 -a (b面なし) 450×2400 (和文文字高70)



C-36 -a (b面なし) 450×2400 (和文文字高70)



C-38 -a (b面なし) 450×2400 (和文文字高70)



C-40 -a (b面なし) 450×2400 (和文文字高70)



C-41 -a 450×1600



C-41 -b



C-42 -a 450×1600



C-42 -b



C-43 -a 450×1600



C-43 -b



C-44 -a 450×2100 (和文文字高120)



C-44 -b



C-45 -a (b面なし) 450×2400 (和文文字高70)



C-46 -a (b面なし) 器具外形寸法H450×W4000 (和文文字高140)

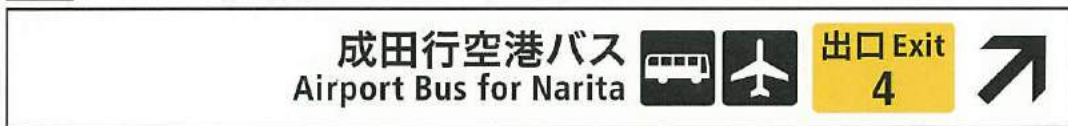

C-47 -a (b面なし) 器具外形寸法H450×W3200×2台 (和文文字高70, 140)



C-48 -a (b面なし) 器具外形寸法H450×W3200 (和文文字高140)



C-49 -a 器具外形寸法H450×W2400 (和文文字高140)



C-49 -b



C-50 -a 器具外形寸法H450×W2400 (和文文字高140)



C-50 -b



C-51 -a 器具外形寸法H450×W1600 (和文文字高70)



C-51 -b



C-52 -a 器具外形寸法H450×W1600 (和文文字高70)



C-52 -b



C-53 -a (b面なし) 器具外形寸法H450×W3200 (和文文字高70, 140)



C-54 -a (b面なし) 器具外形寸法H450×W3200 (和文文字高70, 140)



C-55 -a 器具外形寸法H450×W1600 (和文文字高70)



C-55 -b



C-56 -a 器具外形寸法H450×W2400 (和文文字高140)



C-56 -b



C-57 -a C-58 -a C-59 -a C-60 -a
 C-61 -a C-62 -a C-63 -a C-64 -a

表示面寸法H455×W2640 (和文文字高42)

新宿

ターミナル

Shinjuku Terminal

↓

西口地下広場
West Concourse

JR線 JR |
 小田急線 Odakyu Line |
 京王線 Keio Line

メトロ通路
Metro Underpass

丸ノ内線 Marunouchi Line |
 大江戸線新宿西口駅 Oedo Line, Shinjuku-nishiguchi Sta.

京王新線通路
Keio New Line Concourse

京王新線 Keio New Line |
 都営新宿線 Shinjuku Line |
 大江戸線新宿駅 Oedo Line, Shinjuku Sta.

(既存パネル残置)

C-65 C-66 C-67 C-68 C-69 C-70 表示面寸法H1330×W175 (和文文字高67.6,115)

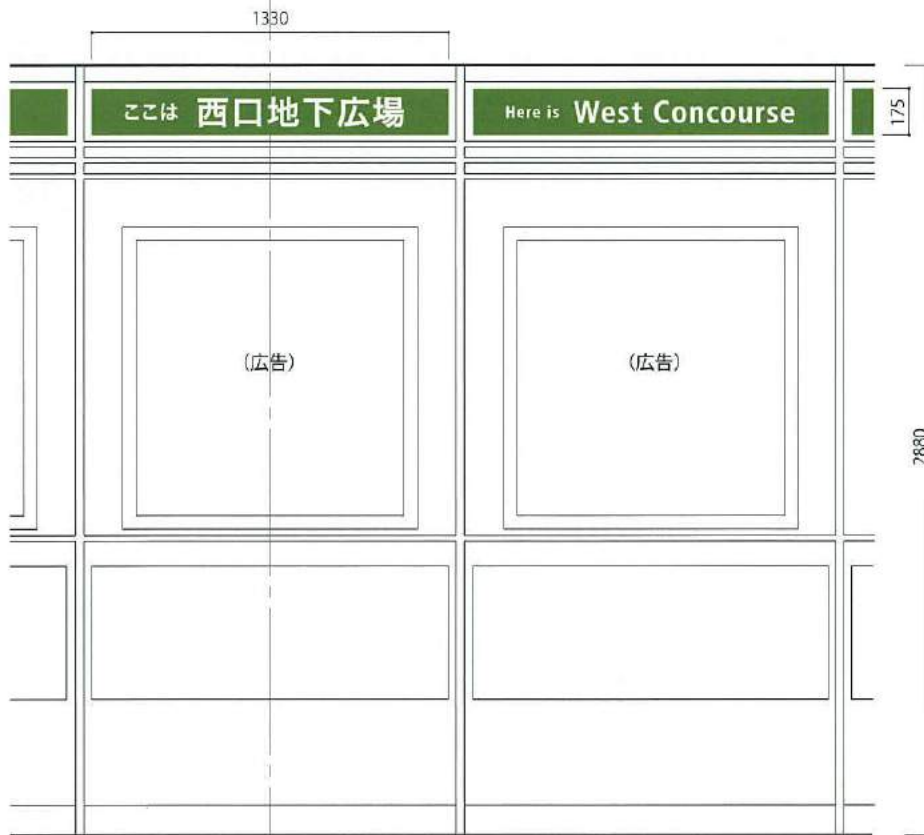
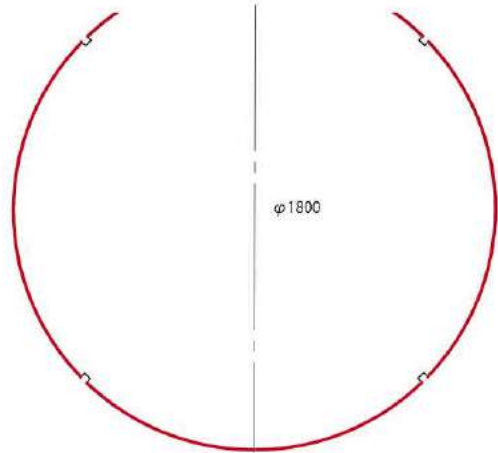

※各柱とも【和文+英文+和文+英文】とする

ここは 西口地下広場

Here is West Concourse

S=1/10

※広告柱 6本を活用



C-図02 エリアマップ(裏側: C-図03 ターミナルマップ)



新設 (無灯式)

C-図01 ターミナルマップ



新設 (内照式)

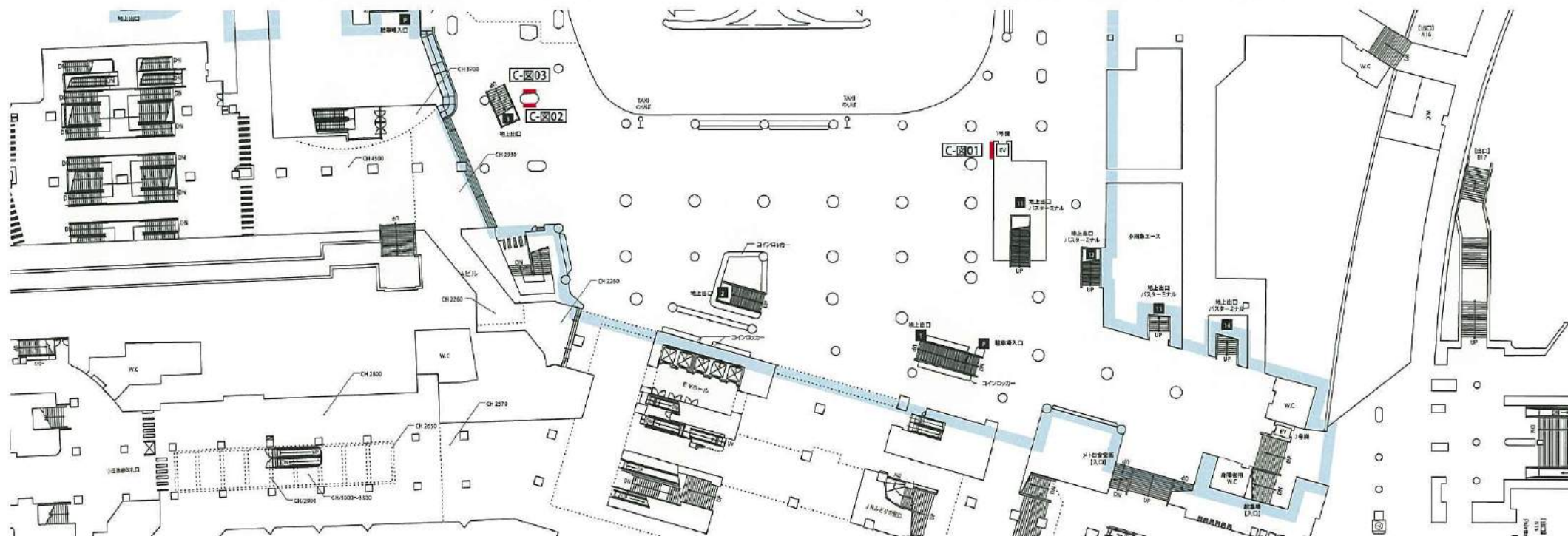

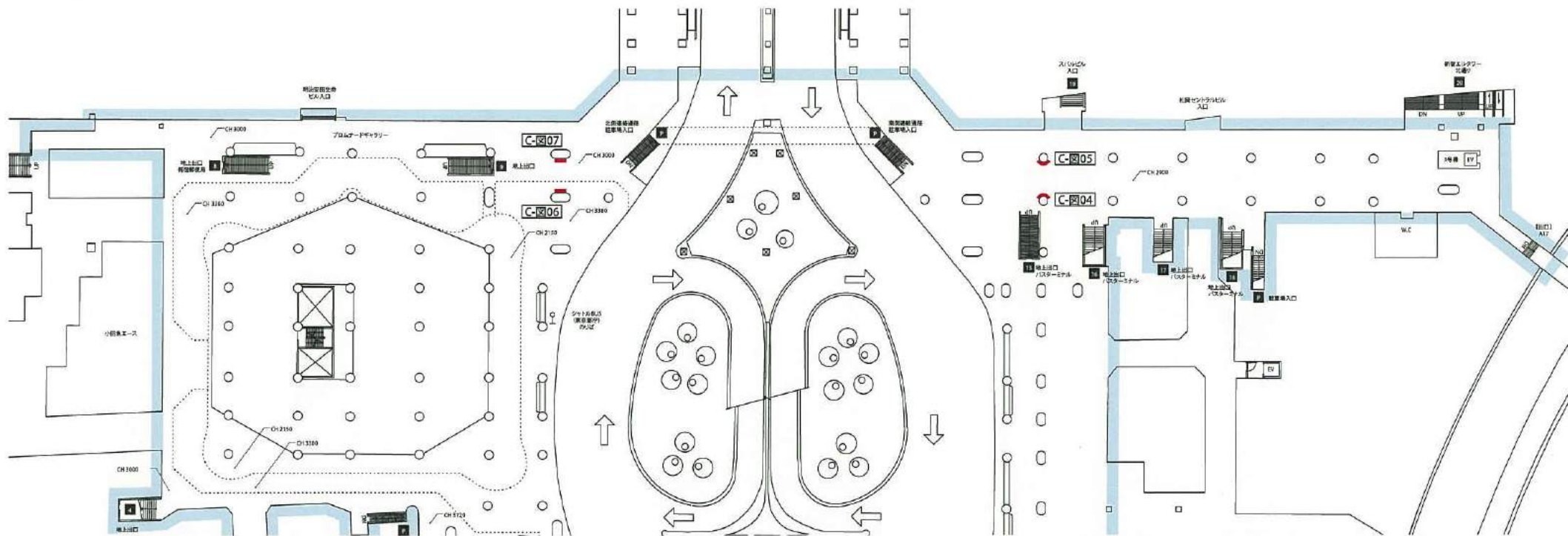

C-図07 エリアマップ



新設（無灯式）

C-図06 ターミナルマップ



新設（無灯式）

C-図04 ターミナルマップ C-図05 エリアマップ



新設（無灯式）

新設（無灯式）



新設内照式器具

C-図01 器具外形寸法H2880×W2600



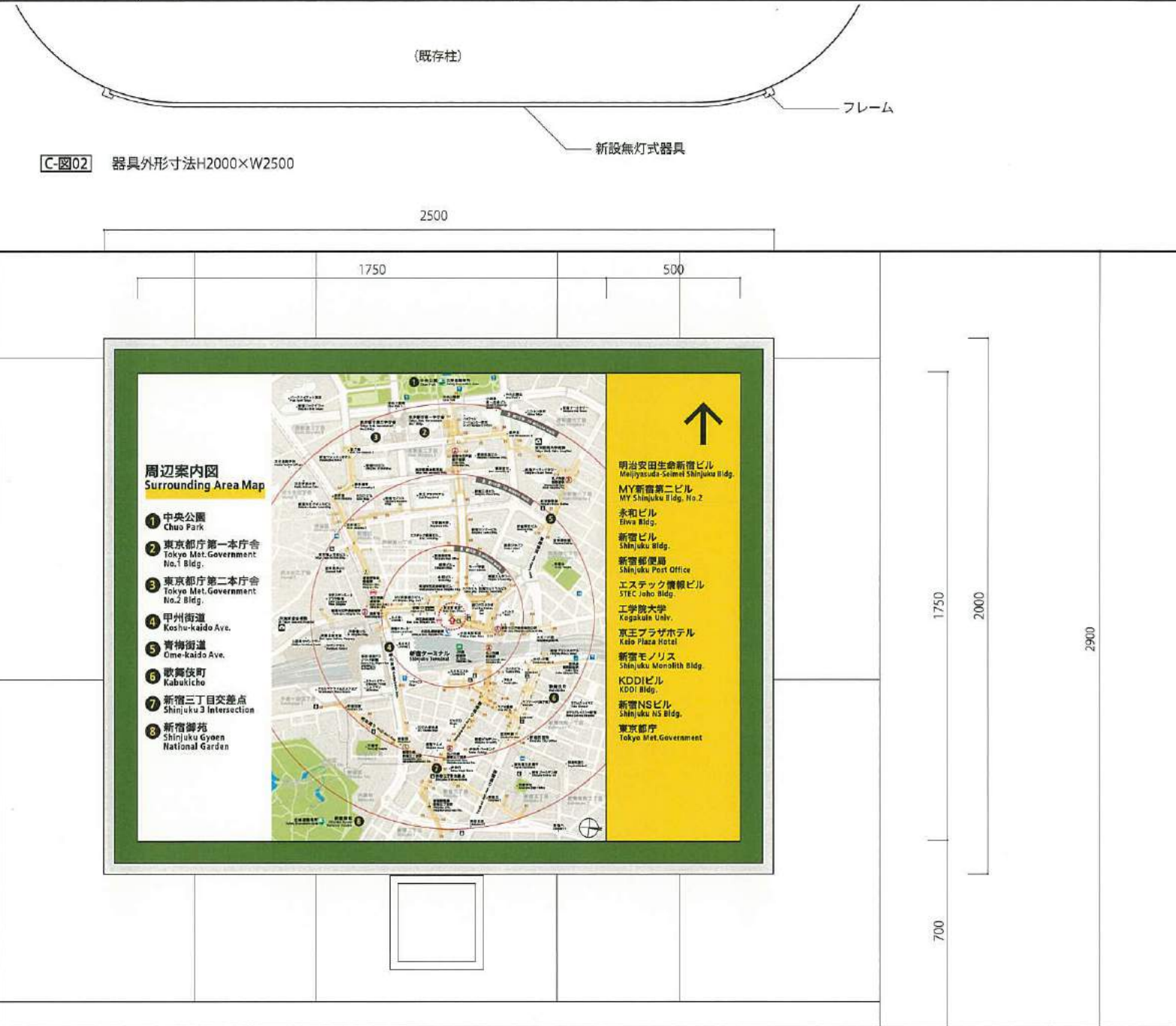

周辺案内図
Surrounding Area Map

- ① 中央公園
Chuo Park
- ② 東京都庁第一本庁舎
Tokyo Met. Government No.1 Bldg.
- ③ 東京都庁第二本庁舎
Tokyo Met. Government No.2 Bldg.
- ④ 甲州街道
Koshu-kaido Ave.
- ⑤ 青梅街道
Ome-kaido Ave.
- ⑥ 歌舞伎町
Kabukicho
- ⑦ 新宿三丁目交差点
Shinjuku 3 Intersection
- ⑧ 新宿御苑
Shinjuku Gyaen National Garden



- ↑
- 明治交田生命新宿ビル
Meijiyasuda-Seimei Shinjuku Bldg.
- MY新宿第二ビル
MY Shinjuku Bldg. No.2
- 永和ビル
Eiwa Bldg.
- 新宿ビル
Shinjuku Bldg.
- 新宿郵便局
Shinjuku Post Office
- エステック情報ビル
STEC Joho Bldg.
- 工学院大学
Kogakuin Univ.
- 京王プラザホテル
Keio Plaza Hotel
- 新宿モリス
Shinjuku Monolith Bldg.
- KDDIビル
KDDI Bldg.
- 新宿NSビル
Shinjuku NS Bldg.
- 東京都庁
Tokyo Met. Government

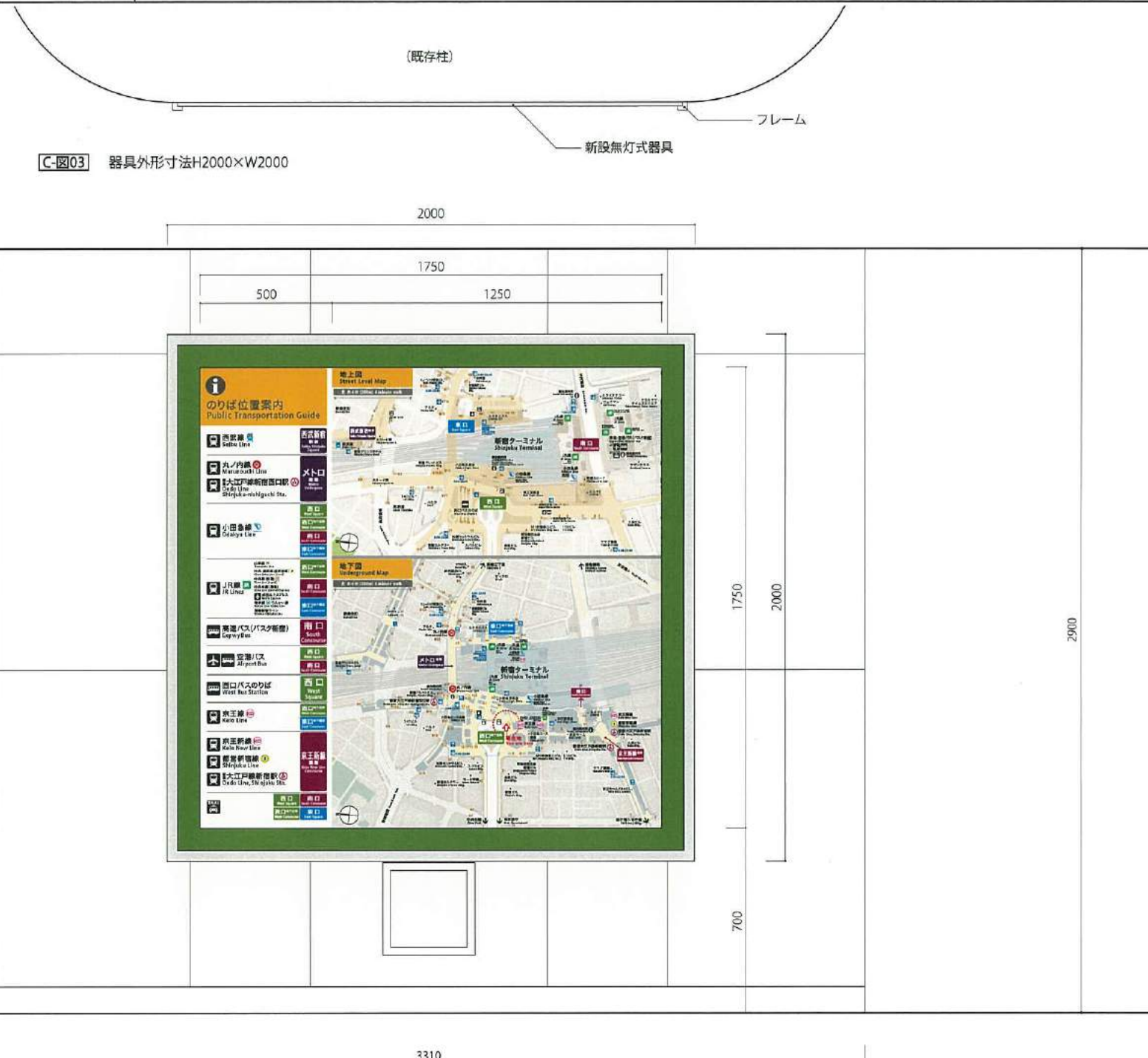

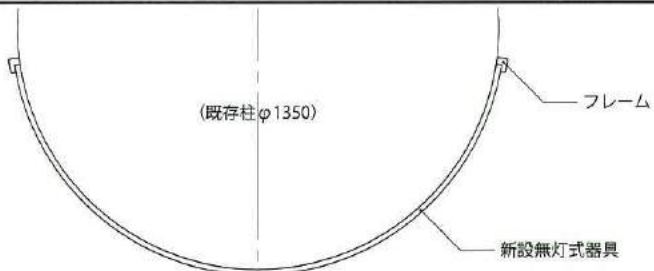

C-図04 器具外形寸法H2000×W2000

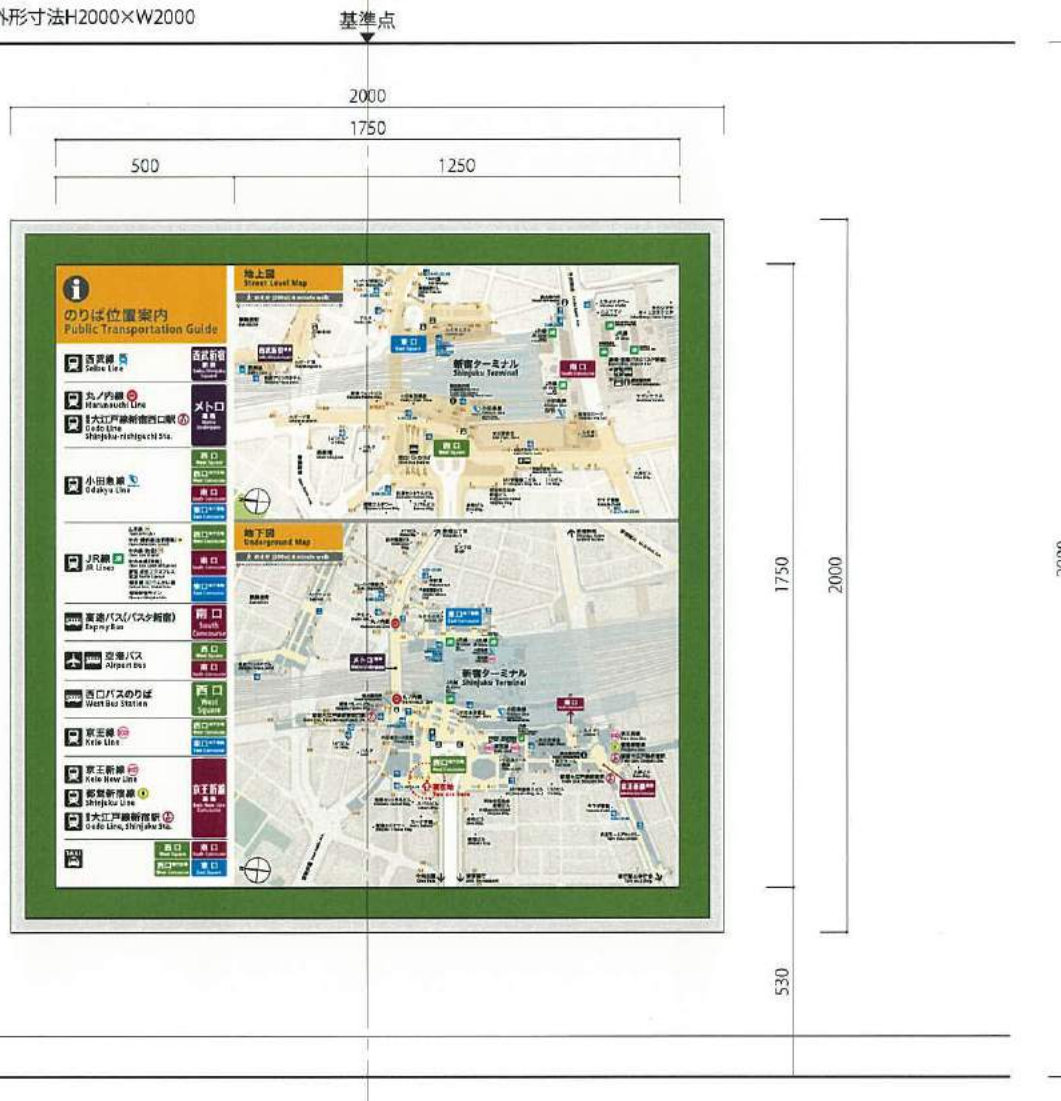

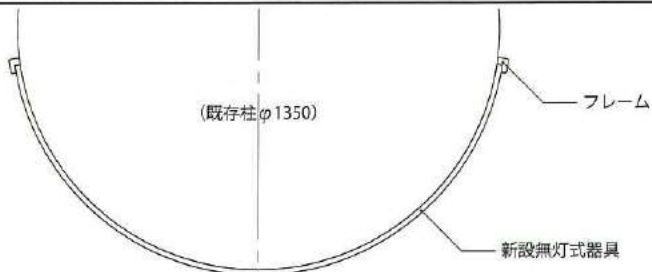

C-図05 器具外形寸法H2000×W2000

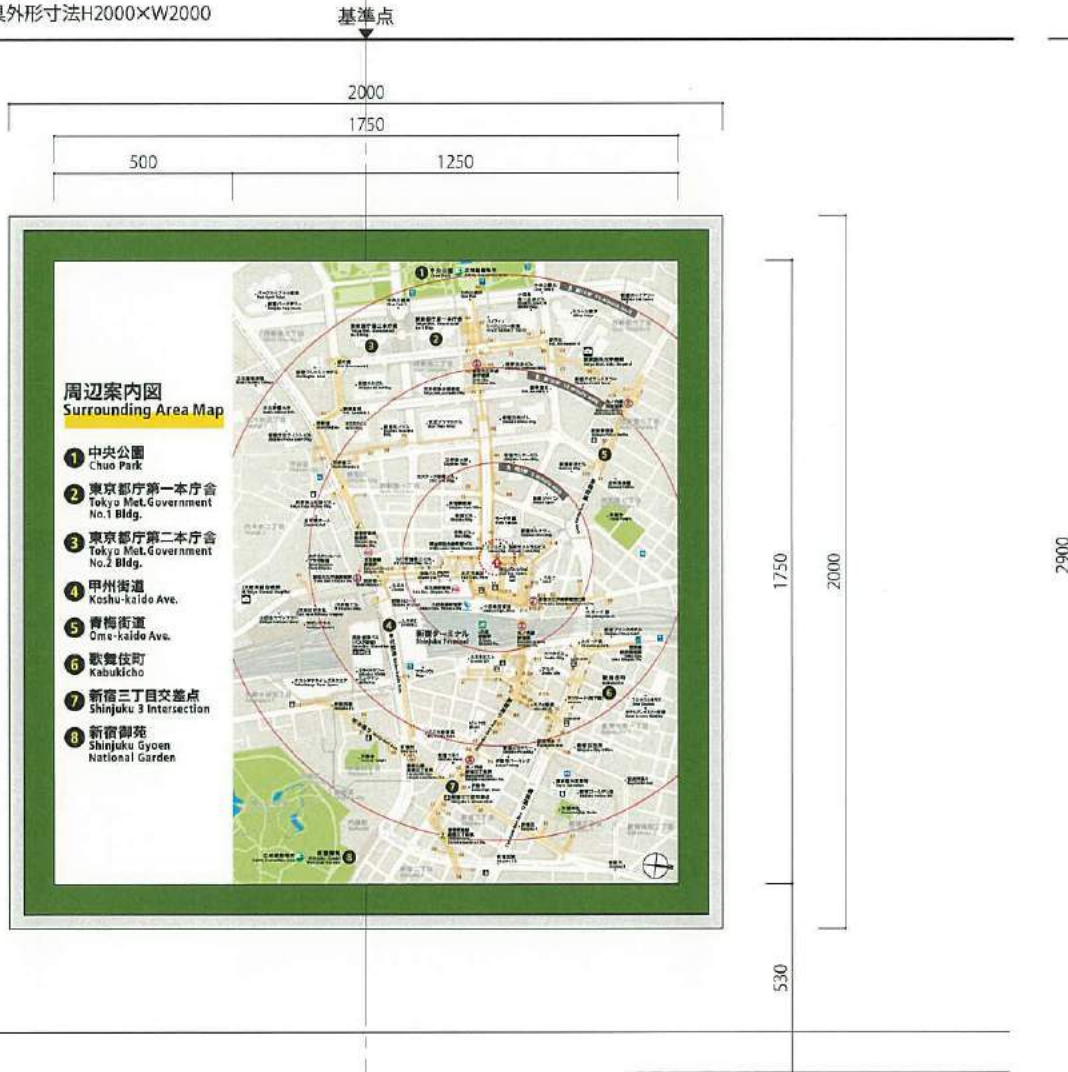



C-図07 器具外形寸法H2000×W2000

